

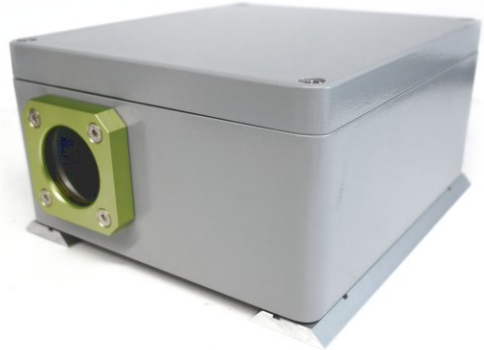

## Benefits:

- Robust construction
- High IP protection class
- High chemical resistance
- Vibration-proof mounting
- Camera mount included
- BK7 or acrylic windows available
- Good heat dissipation thanks to heat conductive tape between camera and enclosure
- Easy assembly
- With Orca adapter also for wide angle lenses
- With Peltier cooling and soon in stainless steel available



## Technical Details:

<b>Dimensions</b> (l x w x h, without cable gland and dovetail mounting plate)	230 x 200 x 111mm
<b>Weight</b> (without dovetail profiles)	Approx. 3000g
<b>Window Materials</b>	BK7, double sided ARC Acrylic, double sided ARC
<b>Window Aperture</b>	45mm
<b>Window Seal</b>	NBR
<b>Colour</b>	Light grey, RAL 7001
<b>Enclosure Material</b>	Powder Coated Aluminum
<b>Enclosure Seals</b>	Polyurethane
<b>Options</b>	- Dovetail mounting plate - Pressure equalising valve for outdoor use

<b>Protection Class</b>	IP66 (Nema 4) IP67 (Nema 6)
<b>Cable Gland Aperture</b> (max. connector size)	26.5mm (M32, GigE) 42mm (M50, Camera Link)
<b>Cable Diameter</b>	Self-drilling
<b>Cable Gland Seal</b>	TPE



The mount guarantees good heat dissipation

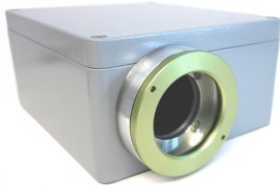

Thanks to the Orca adapter lenses with shorter focal length are also usable





















Chamäleon FX with dovetail profiles to use autoVimation Mounting Kits

### Order Numbers:

Chameleon FX			
Enclosure Type	Order Number	Accessories	Order Number
FX10, M32 (GigE)	20.105.294	Surcharge 2" Acrylic ARC	20.000.049
FX10, M50 (Camera Link)	20.105.291	Surcharge 2" Acrylic FDA	20.000.032
FX17, M32 (GigE)	20.105.293	Dovetail Mounting Plates	20.105.995
FX17, M50 (Camera Link)	20.105.295		
Keyence VS-L	Please ask!		

### Accessories:

Product	Image	Order No.	Product	Image	Order No.	Product	Image	Order No.
2"/3" Wind Curtain		50.100.010 50.100.011	30mm Extension		15.030.030	Mounting Kit 7		5.070.000
2"/3" Wind Curtain		50.100.017 50.100.018	60mm Extension		15.030.085	Mounting Kit 9		5.090.000
Orca adapter		15.030.002	Mounting tool		90.000.004	Mounting Kit 10		5.100.000
Surcharge 3" front lid		20.040.019	Mounting Kit 1		5.010.000	Mounting Kit 15		5.150.000
Surcharge M72 lid		20.040.018	Mounting Kit 2		5.020.000	Mounting Kit 16/16m		5.160.000 5.160.000m
Surcharge Dome lid		20.040.015	Mounting Kit 6		5.060.000	Mounting Kit 17/17m		5.170.000 5.170.000m



### Benefits:

- Peltier cooling up to 30°C temperature difference
- 24V/DC power enables also e.g. supply via solar panels / batteries and so independent operation is possible
- High chemical resistance
- Easy and vibration-proof mounting
- Camera mount included
- High IP protection class



### Technical Details FX Enclosure with Peltier Cooling:

<b>Dimensions</b> (l x w x h, without cable gland and tube)	230 x 200 x 180mm
<b>Weight</b> (without dovetail profiles)	~4900g

<b>Protection Class Enclosure</b>	IP66 (Nema 4) IP67 (Nema 6)
<b>Protection Class Fan</b>	IP54

<b>Ambient Temperature</b>	0 - 70°C
<b>Max. Temp. Difference</b> without camera heat	30°C
<b>Maximum Cooling Power</b>	53,2W at dT=0°C
<b>Input Voltage</b>	24V/DC



Chameleon FX with Peltier Cooling and in stainless steel version with IP69K hygienic design

### Order Numbers:

Chameleon FX Peltier			
Enclosure Type	Order Number	Accessories	Order Number
For FX10, M32 (GigE)	20.106.294	Surcharge 2" Acrylic ARC	20.000.049
For FX10/17, M50 (C. Link) For FX17, M32 (GigE) For Keyence VS, M32/M50	Please ask!	Surcharge 2" Acrylic FDA	20.000.032



## Benefits:

- IP 69K hygienic design
- Stainless steel enclosure in AISI 316L
- High chemical resistance
- Easy and vibration-proof mounting
- Camera mount included
- Good heat dissipation
- Robust and compact design
- Hygienic assembly with special mounting kit to the machine

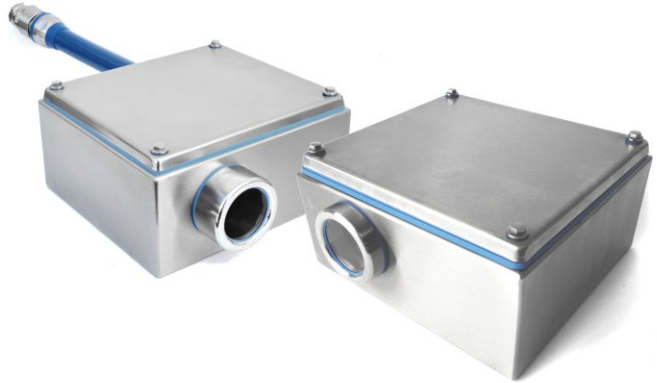

## Technical Details:

<b>Dimensions</b> (l x w x h, without cable gland and tube)	220 x 210 x 108mm
<b>Weight</b> (without tube)	Ca. 4500g
<b>Window Material</b>	BK7, double sided ARC
<b>Window Aperture</b>	45mm
<b>Window Seal</b>	EPDM

<b>Protection Class</b>	IP69K
<b>Cable Gland Aperture</b> (max. connector size)	19mm
<b>Cable Gland Seal</b>	TPE
<b>Enclosure Material</b>	Stainless Steel AISI 316L
<b>Enclosure Seals</b>	Silicone

## Order Numbers:

Chameleon FX Hygienic IP69K			
Enclosure Type	Order Number	Accessories	Order Number
For FX10 (38°, GigE)	20.105.296	Surcharge 2" Acrylic ARC	20.000.049
For FX17 (38°, GigE)	20.105.297	Surcharge 2" Acrylic FDA	20.000.032
For Keyence VS	Please ask!	Hygienic Mounting Kit	20.105.298
		26.5x21 PU Tube	80.007.003



## Chameleon FX

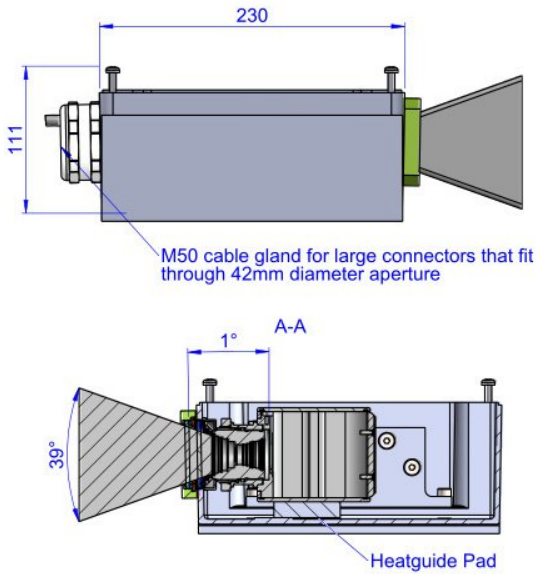

## Chameleon FX Hygienic

