



Benefits:

- Electro-polished V4A stainless steel AISI 316L
- For cameras up to 40 x 40mm cross section
- Robust construction
- Compact size
- High IP protection class
- Flexible camera positioning
- High chemical resistance
- Vibration-proof mounting
- Camera mount included
- Good heat dissipation
- Easy window replacement



Technical Details:

Max. Camera Size (w x h)	40 x 40mm 29 x 47mm	Weight (without camera mount)	Approx. 1700g (Size S) Approx. 2200g (Size M)
Max. Lens Diameter	55mm (in profile) 52mm (in front lid)	Enclosure Material	Electro-polished V4A stainless steel AISI 316L
Inner Length	101 (Size S) 151 (Size M)	Enclosure Seals	EPDM
Enclosure Dimensions (d x l, without cable gland)	69 x 115mm (Size S) 69 x 165mm (Size M)	Cable Gland Aperture (max. connector size)	18.5mm
Window Aperture	45mm	Cable Diameter	Self drilling
Standard Window	BK7, double sided ARC	Cable Gland Seal	TPE
IR Mirror	Order Number: 20.000.010		
Saphire	Order Number: 20.000.016		
Germanium	Order Number: 20.000.017		
Acrylic, uncoated	Order Number: 20.000.058		
Acrylic, double sided ARC	Order Number: 20.000.029		
Window Seal	FKM		
Protection Class	IP66 (Nema 4) IP67 (Nema 6)		



The mount guarantees good heat dissipation



Order Numbers:

Product ID	Camera Height	Camera Length	Enclosure Type	Length
2	29: 0 30: 1 31: 2 32: 3 33: 4 34: 5 35: 6 36: 7 38: 8 40: 9	< 50mm: 3 < 74mm: 5 < 92mm: 7	30	S: 110 M: 160

Accessories:

Product	Image	Order No.	Product	Image	Order No.	Product	Image	Order No.
Position Ring		20.020.003	Mounting Tool		90.000.004	Mount		5.120.000
2" Wind Curtain		50.100.010	Tube for W. Curtain		50.100.017			



Front Lid

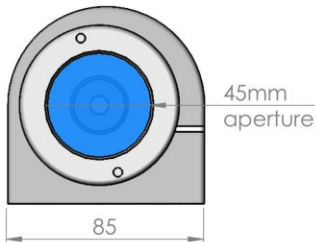

Profile



Size S

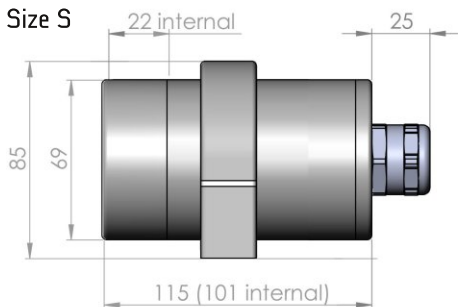

Rear Wall

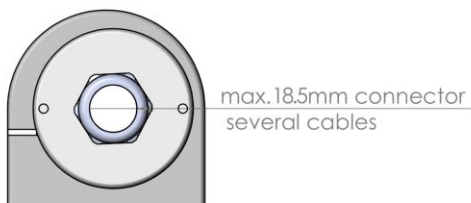

Size M

